





Available online at [www.jlls.org](http://www.jlls.org)

## JOURNAL OF LANGUAGE AND LINGUISTIC STUDIES

ISSN: 1305-578X

*Journal of Language and Linguistic Studies*, 17(Special Issue 2), 848-865; 2021

### Pluralistic approaches to languages and cultures: scale development study

Atilla Özdemir <sup>a 1</sup> , Emine Pehlivan Şişman <sup>b</sup> , Kağan Büyükkaracı <sup>c</sup> 

<sup>a</sup> Suleyman Demirel University, Isparta, Turkey

<sup>b</sup> Suleyman Demirel University, Isparta, Turkey

<sup>c</sup> Suleyman Demirel University, Isparta, Turkey

#### APA Citation:

Özdemir, A., & Pehlivan Şişman, E., & Büyükkaracı, K. (2021). Pluralistic approaches to languages and cultures: a scale development study. *Journal of Language and Linguistic Studies*, 17(Special Issue 2), 848-865.

Submission Date:30/09/2020

Acceptance Date:25/12/2020

#### Abstract

This article is a scale development study aimed at developing valid and reliable scales to understand English language teachers' knowledge about and attitudes towards plurilingualism and interculturalism. It is a descriptive survey model of quantitative research. During the scale development phase, literature review was conducted to develop the item pool. Then, 81 items were adapted from The Framework of Reference for Pluralistic Approaches to Languages and Cultures (FREPA). The draft scale was applied to 349 pre-service English teachers who are third and fourth year university students from five state universities in Turkey. As a result of these analyses, a knowledge scale consisting of 20 items with three factors and an attitude scale with 14 items including three factors were obtained. The reliability of the Plurilingual and Intercultural Knowledge Scale (PIKS) is 0.829, and the reliability of the Plurilingual and Intercultural Attitude Scale (PIAS) is 0.874. Based on the performed analyses, the 5 points Likert-type PIKS and PIAS were developed.

© 2021 JLLS and the Authors - Published by JLLS.

**Keywords:** plurilingualism; intercultural competence; scale development; pluralistic approaches; reliability

## 1. Introduction

In today's globalized world, information is no more a secret. A change made in a country might affect any other place on earth regardless of linguistic and cultural differences (Süssmuth, 2007, p.195). We are globally interdependent, yet communicating across boundaries and languages is still difficult. At this point, being an intercultural citizen plays a vital role to negotiate today's complexities of the world (Byram & Wagner, 2017).

Education in the 21st century should meet the needs of becoming a world citizen. In this regard, language teaching has an important role to promote and maintain necessary knowledge, skills, and attitudes to prepare learners for interacting effectively with people of other languages and cultures. It is widely known in language teaching that learners are expected to use language socially and culturally in an effective way as well as gaining grammatical competence (Byram, Gribkova and Starkey, 2002).

<sup>1</sup> Corresponding author.

E-mail address: [atillaozdemir@sdu.edu.tr](mailto:atillaozdemir@sdu.edu.tr)

Likewise, according to the CEFR, language learning is based on plurilingualism and learners are defined as “social agents” who possess and develop necessary competences and use them appropriately under different circumstances (Council of Europe, 2003). Therefore, developing communicative skills is necessary.

Communicative competence, including plurilingual and intercultural/ pluricultural competence, enable people with necessary knowledge, skills and attitudes to interact effectively with people of other languages and cultures. Barrett, Huber & Reynolds (2014) claims that by developing intercultural competence through education, students can gain skills like multiperspectivity, empathy, cognitive flexibility, interpreting, managing breakdowns in communication and so on. As it can be seen, intercultural communicative competence (ICC) is crucial in today’s world and language teachers are stakeholders of it. According to Byram et al. (2002), the existence of plural languages and cultures need to be demonstrated by teachers. Language teaching is beyond grammar structures and lexical knowledge. They also stated that teachers do not need to know everything about the target culture since there are variety of cultures even within a language. However, this does not mean that we can totally exclude it from teaching process. Foreign language teachers need to come up with a range of activities which raise awareness of other languages and cultures, which help learners be open-minded about different beliefs, values, and behaviors.

On the other hand, previous studies on foreign language teachers’ views about intercultural competence showed that they perceived intercultural competence positively and wished to integrate in their lessons (Özbakır, 2018; Ay, 2018). About implementing ICC in class, Byram et al. (2002) suggests that “the theme of sport can be examined from many perspectives, such as age, gender, religion, racism etc. Other themes like food, homes, school, tourism and leisure time can be examined similarly. Furthermore, we can use grammatical exercises to reinforce prejudice and stereotypes”. As it can be understood from this explanation, there are ways to introduce learners with the elements of intercultural competence as long as teachers are ready for it. Moreover, previous studies in Turkey proved that intercultural competence can be improved via Twitter, critical thinking skills, short stories etc. (Harmandaoğlu, 2013; Çandırılı; 2018; Yaprak, 2018).

In FREPA, it is stated that “pluralistic approaches to languages and cultures refers to didactic approaches which use teaching / learning activities involving several varieties of languages or cultures.” Integrating different languages/ culture into a curriculum is not easy. Curriculum designers, language teachers need to pay special attention to it. However, they need to have a background about the issue and a framework of reference. FREPA bridges this gap with the sample teaching materials and the descriptors divided into ‘knowledge, ‘attitude’ and ‘skills’ subcategories.

According to the United Nations Refugee Agency (UNHCR), 1% of the world’s population has been displaced at the end of 2019. More precisely, 79.5 million people worldwide have been forced to leave their home. This number includes 26 million refugees, and approximately half of them are under the age of 18. Also, data shows that Turkey ranks the highest with 3.6 million refugees among hosting countries (Retrieved on July, 2020). In other words, Turkey experiences a transitional period in welcoming different languages and cultures due to mass migration. Thus, teachers have some difficulties in coping with different languages and cultures in class. Language teachers can help these students in that sense according to their knowledge level. Therefore, this study aims to uncover English language teachers’ knowledge about and attitudes towards plurilingualism and pluriculturalism. Thus, teachers have been experiencing some difficulties in coping with different languages and cultures in class.

## 2. Method

### 2.1. Research design

The aim of this study is to develop valid and reliable scales to understand English language teachers' knowledge about and attitudes towards plurilingualism and interculturalism. It is a descriptive survey model of quantitative research. Survey models are research approaches which aim to describe a past or current situation (Karasar, 2011).

### 2.2. Population and sample

Target population of this study are pre-service English teachers who are third and fourth year university students from five state universities in Turkey.

To collect data, the researcher asked for permissions of EFL instructors at 5 universities (Çukurova University, Gaziantep University, İnönü University, Necmettin Erbakan University, Süleyman Demirel University). In the study convenient sampling method was used. They helped collecting data after their lectures by asking their students to fill in the scale. The researcher preferred to conduct scales on paper. Data collection tool was used in the first semester of 2019-2020 academic year. Pilot study was done with 349 participants attending from five different provinces to develop the data collection tool.

### 2.3. Data collection tool

In this study, the data were collected through Plurilingual and Intercultural Knowledge Scale (PIKS) and Plurilingual and Intercultural Attitude Scale (PIAS) which were developed by the researcher by adapting descriptors in The Framework of Reference for Pluralistic Approaches to Languages and Cultures (FREPA), a publication by Council of Europe.

#### 2.3.1. Development of Plurilingual and Intercultural Knowledge Scale (PIKS) & Plurilingual and Intercultural Attitude Scale (PIAS)

Before the process for developing PIKS and PIAS, literature review was done to establish the theoretical framework and to ground the research. Then, a three-stage process was followed to develop the scale as shown below (Hinkin, 1988; Cohen ve Swerdlik, 2010; Erkuş, 2012, Özdamar, 2016):

1. Stage: Establishing the item pool
2. Stage: Scale development and configuration
3. Stage: Finalizing the scale

Scale development process was planned in three stages.

Purposes and research methods were determined separately for each stage, and item pool was created first.

##### 2.3.1.1. Establishing item pool

Literature was reviewed about the subject. A publication on pluralistic approaches to languages and cultures, "A Framework of Reference for Pluralistic Approaches to Languages and Cultures" (FREPA), by Council of Europe was determined to be used as the resource for scales. It consists of three main parts; knowledge, attitude and skill. The researcher only benefited from "knowledge" and "attitude" parts of FREPA. "Skills" part was excluded in this study because it is quite difficult to assess plurilingual and intercultural competencies via a scale. 64 items were constructed based on among FREPA

descriptors marked as “essential” and “important” from “knowledge” part (PIKS) and 17 items from “attitude” part (PIAS). Participants were expected to respond their agreement level in a 5-point Likert scale; SA= Strongly agree, A= Agree, N= Neither agree nor disagree, D=Disagree, SD= Strongly disagree.

Scale development and configuration stages are presented in Figure 1.

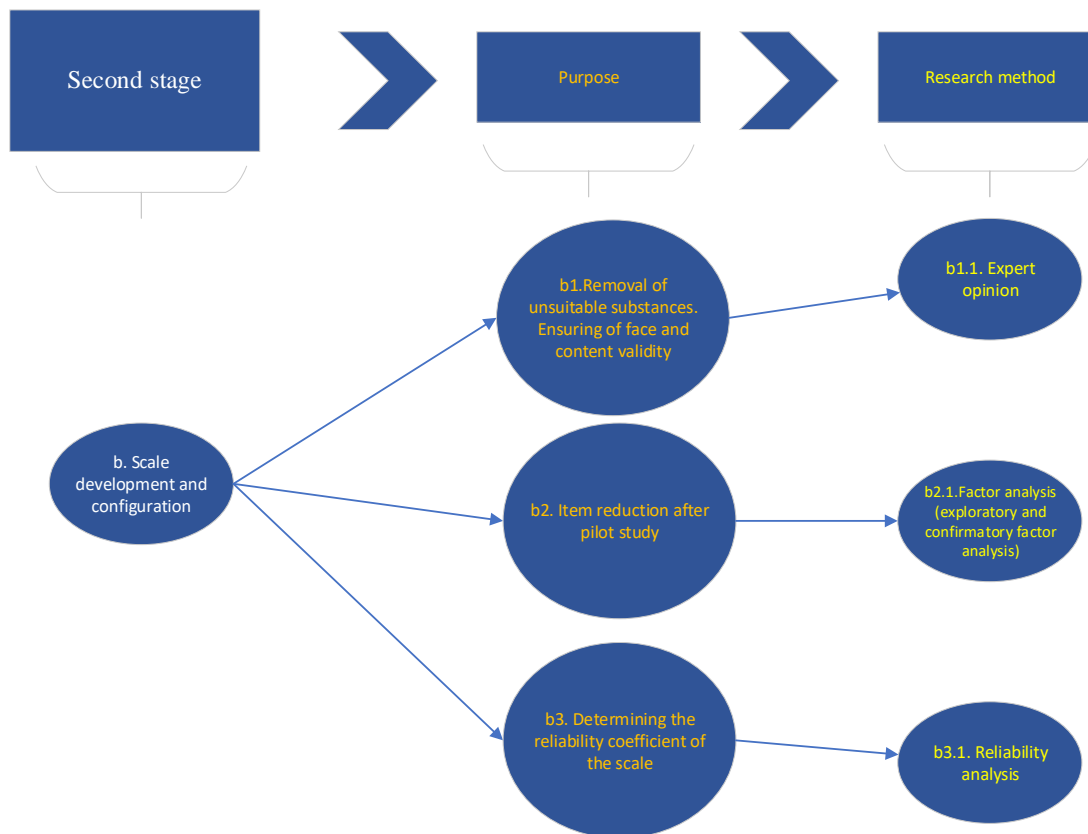

**Figure 1.** Plurilingual and Intercultural Knowledge & Attitude Scales Development Model (Stage 2)

At this stage, pilot study was implemented to 349 pre-service English teachers from five state universities in Turkey. Exploratory and confirmatory factor analysis were applied to results and overlapping items were removed. Consequently, number of items decreased to 20 in PIKS scale and 14 in PIAS. The results obtained from Plurilingual and Intercultural Knowledge Scale (PIKS) are shown in Table 1, and Plurilingual and Intercultural Attitude Scale (PIAS) are demonstrated in Table 2.

**Table 1.** Appropriateness rate of items in PIKS under development

Items	Appropriate %	Inappropriate%	Items	Appropriate%	Inappropriate %
K1	20	80	K33	10	90
K2	40	60	K34	20	80
K3	30	70	K35	10	90
K4	0	100	K36	100	0
K5	10	90	K37	70	30
K6	20	80	K38	0	100
K7	10	90	K39	100	0
K8	30	70	K40	0	100
K9	100	0	K41	30	70
K10	100	0	K42	100	0
K11	0	100	K43	100	0
K12	10	90	K44	0	100

<b>K13</b>	20	80	<b>K45</b>	0	100
<b>K14</b>	0	100	<b>K46</b>	0	100
<b>K15</b>	0	100	<b>K47</b>	0	100
<b>K16</b>	0	100	<b>K48</b>	100	0
<b>K17</b>	10	90	<b>K49</b>	100	0
<b>K18</b>	10	90	<b>K50</b>	100	0
<b>K19</b>	20	80	<b>K51</b>	10	90
<b>K20</b>	10	90	<b>K52</b>	100	0
<b>K21</b>	20	80	<b>K53</b>	30	70
<b>K22</b>	100	0	<b>K54</b>	0	100
<b>K23</b>	80	20	<b>K55</b>	0	100
<b>K24</b>	100	0	<b>K56</b>	0	100
<b>K25</b>	100	0	<b>K57</b>	0	100
<b>K26</b>	10	90	<b>K58</b>	20	80
<b>K27</b>	10	90	<b>K59</b>	100	0
<b>K28</b>	0	100	<b>K60</b>	0	100
<b>K29</b>	100	0	<b>K61</b>	10	90
<b>K30</b>	10	90	<b>K62</b>	0	100
<b>K31</b>	100	0	<b>K63</b>	100	0
<b>K32</b>	0	100	<b>K64</b>	0	90

As a result of the feedback from the experts, the levels of agreement were calculated for each item separately. While evaluating the items, the experts are asked to express the items as necessary (available, suggestion for correction) or unnecessary according to these questions: "Can the item represent the property to be measured?", "Is the item easily understood by the target audience?" and "Can the item be included in the specified factor?". In the light of the obtained numerical data and criticisms, the items for the pilot study were selected as follows (Büyüköztürk, Çakmak, Akgün, Karadeniz and Demirel, 2013, p.133): Items between 90-100% were included in the scale and 70-80% for the items that showed a match. It was revised in line with the criticisms received. It was expressed in revised items and corrections were made on the basis of words. As it can be seen in Table 1.

Thus, appearance and content evidence validity were provided by seeking expert opinions (Muijs, 2004, Şencan, 2005; Tavsancil, 2005). Another process done in the second stage is pilot application. Exploratory and confirmatory factor analyses were performed on the data obtained as a result of the pilot study, and then the stratified alpha coefficient was calculated as 0.829 as the reliability coefficient of the scale.

Similarly, expert opinion was consulted in the second scale to be developed. The results obtained are given in Table 2.

**Table 2.** Appropriateness rate of items in PIAS under development

<b>Items</b>	<b>Appropriate %</b>	<b>Inappropriate%</b>
<b>A1</b>	100	0
<b>A2</b>	100	0
<b>A3</b>	100	0
<b>A4</b>	90	10
<b>A5</b>	0	100
<b>A6</b>	10	90
<b>A7</b>	10	90
<b>A8</b>	100	0
<b>A9</b>	90	10
<b>A10</b>	100	0
<b>A11</b>	90	10
<b>A12</b>	100	0
<b>A13</b>	100	0
<b>A14</b>	70	30

<b>A15</b>	100	0
<b>A16</b>	80	20
<b>A17</b>	100	0

Accordingly, items A5, A6 and A7 were removed from the scale in accordance with their expert opinions. Backwards A1, A2, A3, A4, A8, A9, A10, A11, A12, A13 and A14 and the 14-item scale was made ready for pilot study.

Likewise in PIKS, exploratory and confirmatory factor analyzes were done on the data. The stratified alpha coefficient was calculated as 0.874 as the reliability coefficient of the scale.

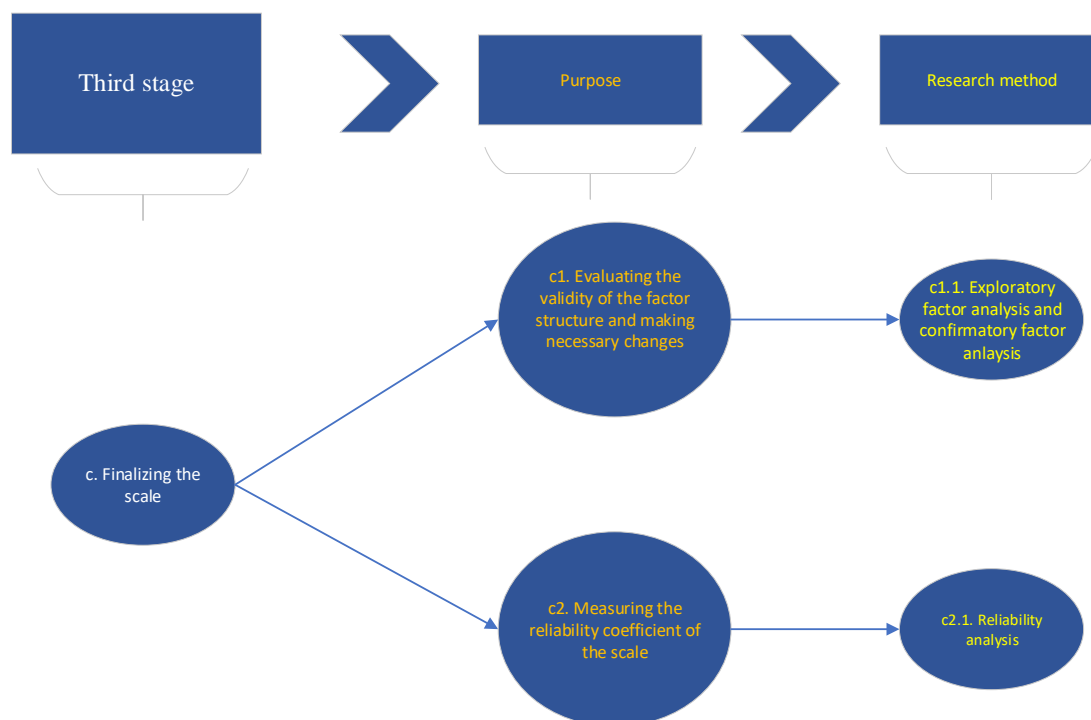

**Figure 2.** Plurilingual and Intercultural Knowledge Scale & Plurilingual and Intercultural Knowledge Scale Development Model (Stage 3)

At this stage, the results obtained from construct validity and reliability analyses were found. Construct validity will be emphasized first.

Explanatory Factor Analyse (EFA) and Confirmatory Factor Analyse (CFA) techniques were used to determine the validity of the structure which is one of the validity types and which can be expressed as the measurement status of the conceptual / theoretical structure that the measuring tool aims to measure (Worthington and Whittaker, 2006).Scree plot was used to determine the number of factors extracted according to EFA results.

### 3. Results

#### 3.1. Construct validity

##### 3.1.1. Scale: Findings of Exploratory Factor Analyses of PIK and PIAS

Before conducting exploratory factor analysis , possibility of missing data and normality assumptions were checked for the suitability of the data. Firstly, sample size was checked. Even though there is no exact agreement about sample size in scale development studies, general opinion is that the acceptable

number of participants should be 5 to 10 times of the number of items in the scale (Kline, 1994; Hinkin, 1995; Comrey ve Lee, 2013; Pallant, 2013). Yet, Büyüköztürk (2002) stated that a sample size between 100 and 200 is adequate to find strong and clear factors. Pilot study was conducted in four state universities in Turkey. Especially, 3rd and 4th year university students, who are expected to be EFL teachers in the near future, were selected. The scale was applied to 357 participants in total. In order to avoid any problem about missing value in collected data, 8 datas with missing information were excluded from the study. Consequently, 349 datas were included in construct validity and reliability studies for pilot study. In addition, there was no extreme value problem in the data.

Basic purpose of factor analysis is to obtain a small number of significant variables from many variables which are thought to measure the same structure (Comrey and Lee, 2013). Kaiser-Meyer-Olkin (KMO) coefficient and Bartlett's test of sphericity results were checked to determine appropriateness and adequacy of 349 collected data for exploratory factor analysis. KMO value of the scale was found 0.813 When this value is greater than .50, it means dataset is appropriate for factor analysis. If this value is high, it is presumed that each variable can be perfectly predictable by the other variables (Çokluk, Şekercioğlu, Büyüköztürk, 2014: 207). For PIKS, Barlett's test of sphericity was found as  $\chi^2=1392.988$ ,  $sd=190$ ,  $p=.00$ . Results of Bartlett's test of sphericity generate a chi-square statistic. On the other hand, for PIAS, Barlett's test of sphericity was found as  $\chi^2=1562.531$ ,  $sd=91$ ,  $p=.00$ . Results of Bartlett's test of sphericity generate a chi-square statistic. Dataset is suitable for factor analysis when this value is below .05 (Yurdagül, 2005). Besides, when the item correlations are examined, it was revealed that there is no low relation between the items and the matrix does not have a unit matrix feature. Therefore, it is concluded that obtained dataset is sufficient for exploratory factor analysis.

At this stage, it is paid attention to have item-total correlation value as .40 and item eigen value as .10 to determine the items in the final form of the scale (Büyüköztürk, 2007). All items with total correlation values on .40. The varimax vertical rotation technique was applied to determine the factor distributions of the items. Scale eigen value was collected under 3 factors greater than 1. The variance rate explained according to the items in the final scales are shown in Tables 3 and 4.

**Table 3.** Explained Variance Table for PIKS

Dimension	Eigenvalue	Explained Variance
1	4.497	22.483
2	2.133	10.665
3	1.325	6.624
		39.772

According to Table 3, eigen value of each 3 dimensions is greater than 1. Additionally, 3 dimensions explore %40 of total variance. It is the first factor exploring the most with % 22 of the total variance.

**Table 4.** Explained Variance Table for PIAS

Dimension	Eigenvalue	Explained Variance
1	4.911	35.077
2	1.565	11.178

3

1.084

7.745

54.001

As it can be seen in Table 4, eigen value of each 3 dimensions is greater than 1. Also, 3 dimensions explore %54 of total variance. It is the first factor exploring the most with % 35 of the total variance.

When the graphic in Figure 3 below, which is formed as a result of “scree plot” obtained through factor analysis, is examined, the PIKS scale is collected under 3 factors.

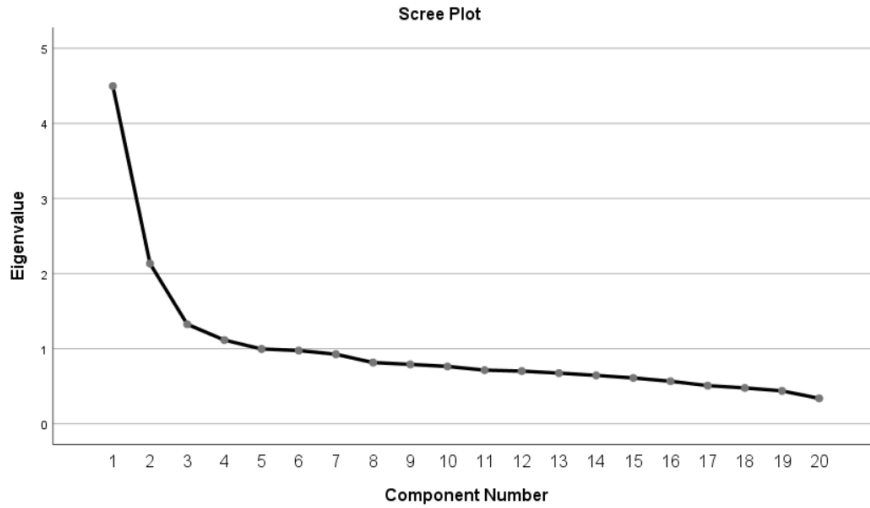

**Figure 3.** Aggregation plot of the items according to “Scree Plot” in Plurilingual and Intercultural Knowledge Scale (PIKS)

The graphic in Figure 4, formed as a result of “scree plot” obtained through factor analysis, shows that the PIAS scale is collected under 3 factors, too.

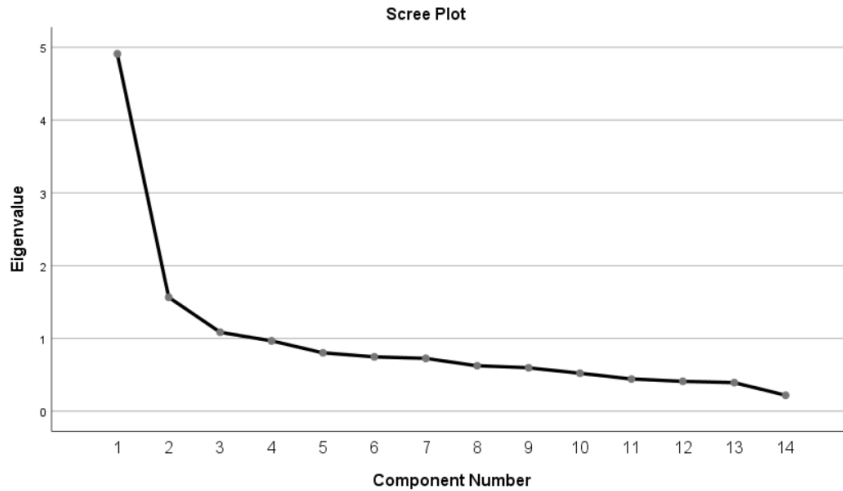

**Figure 4.** Aggregation plot of the items according to “Scree Plot” in Plurilingual and Intercultural Knowledge Scale (PIAS)

When the result of “Scree Plot” of the Plurilingual and Intercultural Knowledge Scale was examined, it is seen that the scale is collected under 3 factors and it explains 54 % of total variation. Factor loads of the items consisting of 3 dimensions are shown in Tables 5 and 6.

**Table 5.** Rotated Factor Load Table for PIKS



	Factor 1	Factor 2	Factor 3
K1	0.732		
K2	0.642		
K3	0.600		
K4	0.596		
K5	0.564		
K6	0.526		
K7	0.518		
K8		0.682	
K9		0.662	
K10		0.625	
K11		0.618	
K12		0.564	
K13		0.439	
K14		0.422	
K15			0.693
K16			0.580
K17			0.579
K18			0.573
K19			0.552
K20			0.478

When Table 5 is examined, it is observed that the factor loadings of the items, which consist of 20 items collected under three dimensions, ranged between 0.422 and 0.732 and exceeded the acceptance level of .40. Also, it was found that the 3 factor scale explained %40 of the total variance and was quite above the sufficient level of 30% (Çokluk, Şekercioglu and Büyüköztürk, 2014).

**Table 6.** Rotated Factor Load Table for PIAS

	Factor 1	Factor 2	Factor 3
A1	0.849		
A2	0.685		
A3	0.851		
A4	0.676		
A5	0.503		
A6		0.701	
A7		0.671	
A8		0.651	
A9		0.600	
A10		0.544	
A11			0.783
A12			0.775
A13			0.664
A14			0.572

On the other hand, Table 6 demonstrates that the factor loadings of the items, which consist of 14 items collected under three dimensions, ranged between 0.503 and 0.849 and exceeded the acceptance level of .40. Moreover, the 3 factor scale explained %54 of the total variance and was quite above the

sufficient level of 30% (Çokluk, Şekercioğlu and Büyüköztürk, 2014). As a consequence, naming of factors and which items were collected under these factors are demonstrated in Tables 7 and 8.

**Table 7.** Items Related to Factors and Naming of Factors for PIKS

Factor	Factor Names	Item Numbers	Variance	Reliability (alpha)	Correlation		
					1	2	3
1	Plurilingualism, similarities and differences of languages	1,2,3,4,5,6,7	10.026	0.741	.274	.480	
2	Cultural diversity, intercultural relations, and culture learning/ acquisition	8,9,10,11,12,13,14	13.198	0.701			.372
3	General characteristics, similarities and differences of cultures	15,16,17,18,19,20	8.030	0.707			
All Items			53.815	0.829			

**Table 8.** Items Related to Factors and Naming of Factors for PIAS

Factor	Factor Names	Item Numbers	Variance	Reliability (alpha)	Correlation		
					1	2	3
1	Respect and curiosity to languages and cultures	1,2,3,4,5	9.821	0.806	.563	.364	
2	Readiness to adapt languages and cultures	6,7,8,9,10	9.521	0.737			.491
3	Approach to languages and cultures	11,12,13,14	8.303	0.714			
All Items			52.038	0.874			

Possible factor names were presented to the experts in the field, and the most appropriate ones were approved as can be seen in Table 7 and 8.

### 3.2. Findings of Confirmatory Factor Analysis (CFA)

While developing a new scale, it is not appropriate to perform only exploratory factor analysis, but it is also recommended to examine the confirmatory factor analysis of the pre-configured scale (Hinkin, 1995; Brown, 2015). For this purpose, to test 3 factor design of the PIKS and PIAS, CFA was applied to the scale with 20 items. Factor analysis diagram obtained through the analysis of the PIKS (N=349) is given in Figure 5 and model fit indices are shown in Table 9.

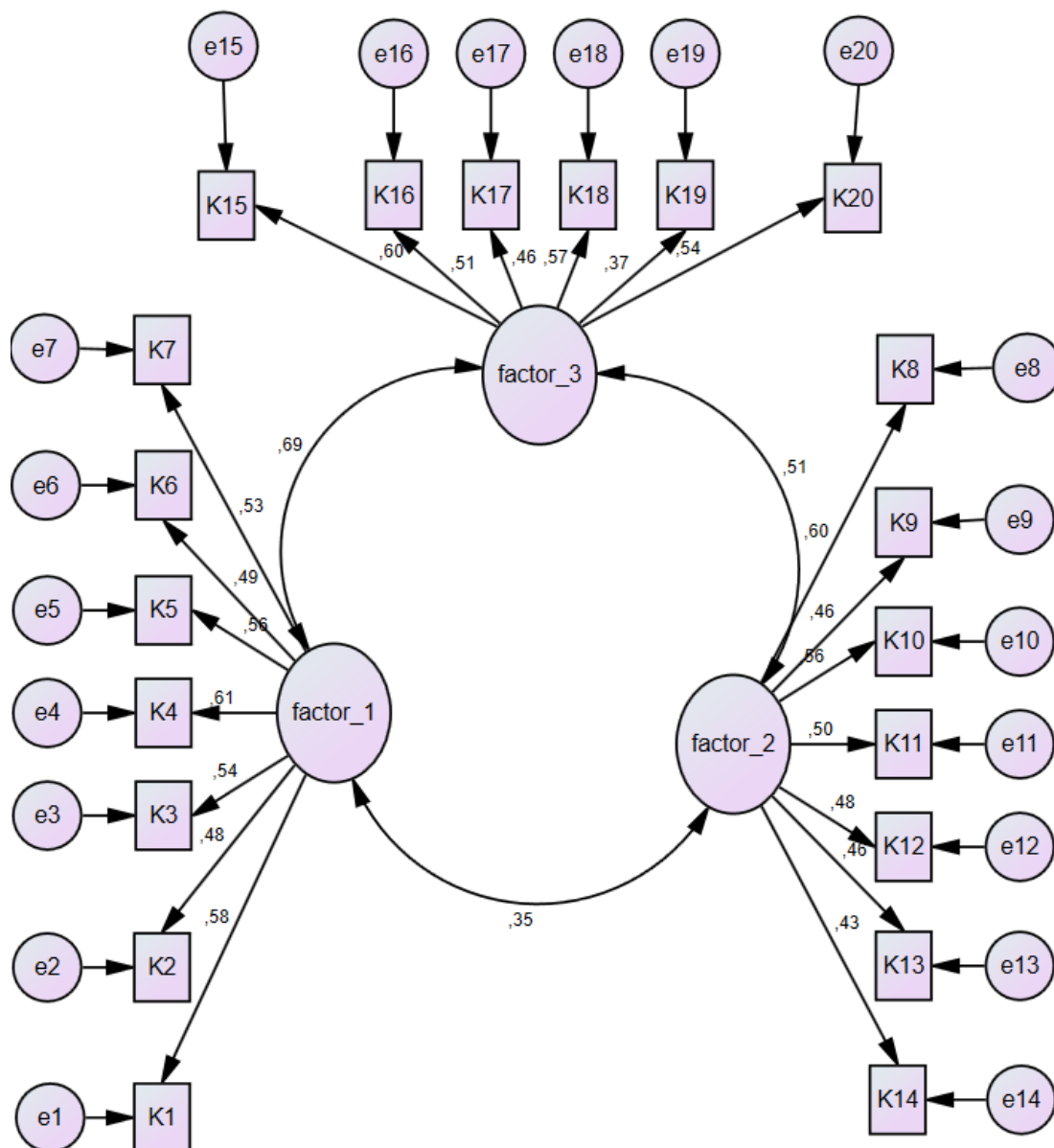

**Figure 5.** Plurilingual and Intercultural Knowledge Scale (PIKS) Confirmatory Factor Analysis (CFA) Diagram

“Maximum likelihood method” was used to perform analyses in which CFA diagram in Figure 6 was obtained. As a result of the analysis of 3 dimensional structured scale, all the items received load values in the relevant dimensions were found to be varied between .43 and .69.

In order to test 3 factor design of the PIAS, CFA was applied to the scale with 14 items. Factor analysis diagram obtained through the analysis of the other half (PIAS) of the collected data (N=349) is given in Figure 6.

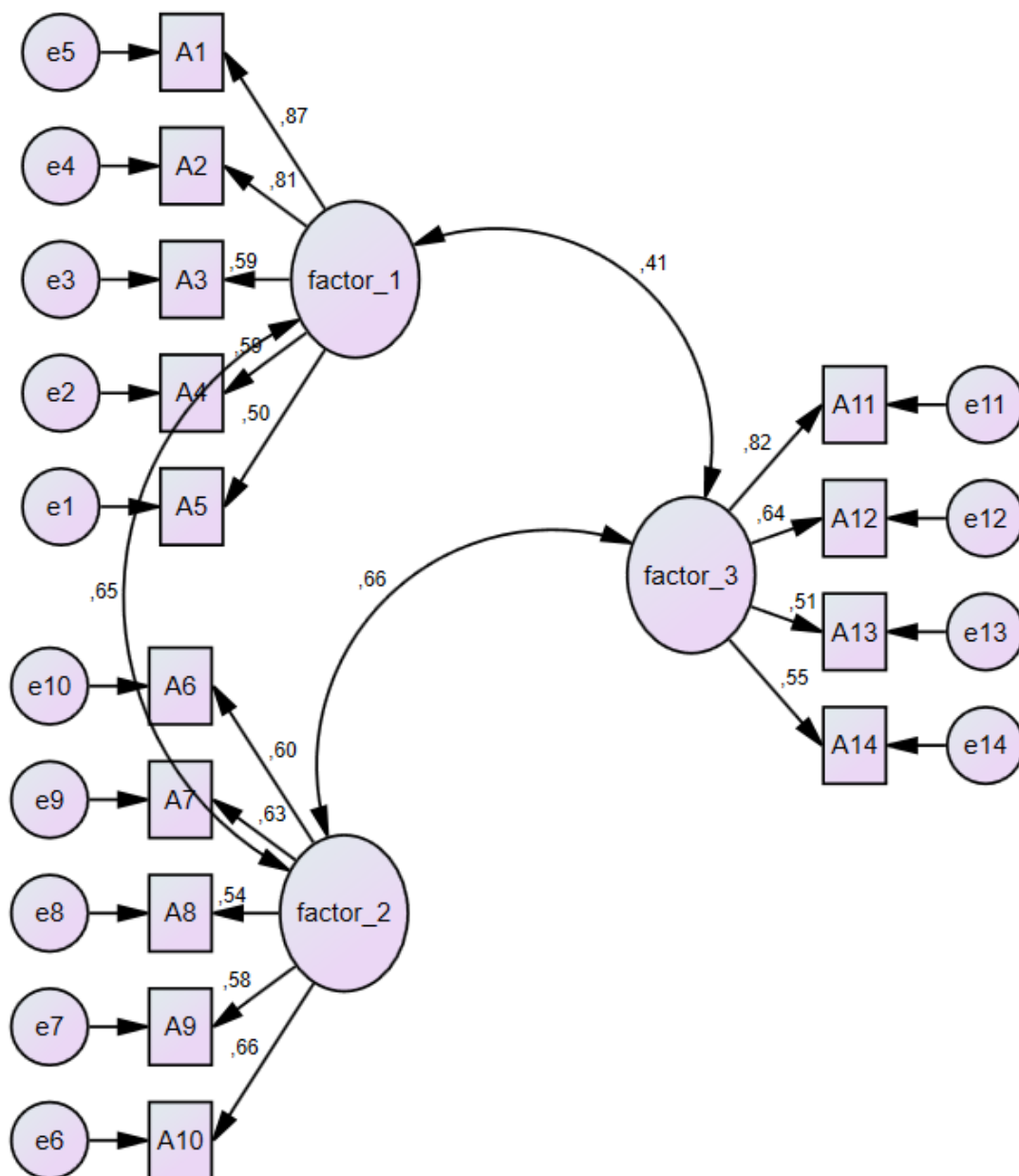

**Figure 6.** Plurilingual and Intercultural Knowledge Scale (PIAS) Confirmatory Factor Analysis (CFA) Diagram  
 As a result of the same analysis conducted for the PIAS, CFA diagram in Figure 6 was obtained. All the items received load values in the relevant dimensions were estimated to be varied between .51 and .87. Apart from that, model data fit indices are given in Table 9 for PIKS and in Table 10 for PIAS.

**Table 9.** Plurilingual and Intercultural Knowledge Scale (PIKS) CFA Fit Indices

Indice	Perfect Fit	Acceptable Fit	Research Findings	Result
$\chi^2/df$	$\chi^2/df < 3$	$\chi^2/df < 4-5$	2.147	Perfect Fit
RMSEA	$0 \leq RMSEA \leq .05$	$.05 \leq RMSEA \leq .08$	0.057	Acceptable Fit
SRMR	$0 \leq SRMR \leq .05$	$.05 \leq SRMR \leq .10$	0.075	Acceptable Fit
NFI	$.95 \leq NFI \leq 1$	$.90 \leq NFI < .95$	0.948	Acceptable Perfect Fit
CFI	$.97 \leq CFI \leq 1$	$.95 \leq NFI < .97$	0.942	Acceptable Fit
NNFI	$.95 \leq NNFI \leq 1$	$.90 \leq NNFI < .95$	0.947	Acceptable Fit

According to the CFA results, using maximum likelihood estimation in Table 9, compliance values were found as  $\chi^2/sd=2.147$ , RMSEA= 0.057, SRMR= 0.075, NFI =0.948, CFI = 0.942, NNFI= 0.947.

**Table 10.** Plurilingual and Intercultural Attitude Scale (PIAS) CFA Fit Indices

Indice	Perfect Fit	Acceptable Fit	Research Findings	Result
$\chi^2/df$	$\chi^2/df < 3$	$\chi^2/df < 4-5$	2.914	Perfect Fit
RMSEA	$0 \leq RMSEA \leq .05$	$.05 \leq RMSEA \leq .08$	0.074	Acceptable Fit
SRMR	$0 \leq SRMR \leq .05$	$.05 \leq SRMR \leq .10$	0.042	Perfect Fit
NFI	$.95 \leq NFI \leq 1$	$.90 \leq NFI < .95$	0.964	Perfect Fit
CFI	$.97 \leq CFI \leq 1$	$.95 \leq NFI < .97$	0.955	Acceptable Fit
NNFI	$.95 \leq NNFI \leq 1$	$.90 \leq NNFI < .95$	0.902	Acceptable Fit

Considering the CFA results of PIAS in Table X, compliance values were found as  $\chi^2/sd=2.914$ , RMSEA= 0.074, SRMR= 0.042, NFI =0.964, CFI = 0.955, NNFI= 0.902. When the values are analyzed for both scales, it is seen that all of them are in perfect fit or acceptable fit. Consequently, according to this obtained model, it was seen that factors were confirmed by data (Tabachnick ve Fidell, 2001; Hooper, Coughlan & Mullen, 2008).

Accordingly, in 3 factor PIKS scale with 20 items, minimum score can be obtained is 20 and maximum score is 100. The reliability of the finalized PIKS and its 3 sub-dimensions was examined with Cronbach alpha and details were given in Table 11.

**Table 11.** Reliability Table for PIKS

	Cronbach Alpha	Number of items (N)
All Scale (Stratified Alfa)	0.829	20
1. Dimension	0.741	7
2. Dimension	0.701	7
3. Dimension	0.707	6

Kalaycı (2008) states that depending on the alpha ( $\alpha$ ) coefficient, the reliability of the scale can be interpreted as follows:

If it is  $0.00 \leq \alpha < 0.40$  , scale is not reliable.

If it is  $0.40 \leq \alpha < 0.60$  , scale reliability is low.

If it is  $0.60 \leq \alpha < 0.80$  , scale is quite reliable.

If it is  $0.80 \leq \alpha < 1.00$  , scale is highly reliable.

So, the reliability for the PIKS was 0.829 and the scale is highly reliable. Reliability in sub-dimensions is highest in first dimension and it is 0.741 which is quite reliable. Second dimension's reliability was obtained as 0.701 and it is also quite reliable. In the third dimension, reliability was obtained as 0.707 and it is quite reliable, too.

On the other hand, in PIAS with 14 items, minimum score can be obtained is 14 and maximum score is 70. The reliability of the final scale and its 3 sub-dimensions was calculated with Cronbach alpha and details were shown in Table 12.

**Table 12.** Reliability Table for PIAS

	Cronbach Alpha	Number of items (N)
All Scale (Stratified Alfa)	0.874	14
1. Dimension	0.806	5
2. Dimension	0.737	5
3. Dimension	0.714	4

As can be seen in Table 12, the reliability for the PIAS was calculated as 0.874 and the scale is highly reliable. Reliability in sub-dimensions is highest in first dimension and it is 0.806. It has high reliability. Second dimension reliability was obtained as 0.737 and it is quite reliable. In the final dimension, reliability was obtained as 0.714 and it has high reliability.

#### 4. Conclusions

The aim of this study was to determine pre-service English teachers' knowledge and attitudes about plurilingualism and interculturalism. In line with this objective, a 20-item Plurilingual and Intercultural Knowledge Scale and a 14-item Plurilingual and Intercultural Attitude Scale, each consisting of three domains, were developed. In order to test validity, exploratory factor analyses and confirmatory factor analyses were conducted. Cronbach's alpha was calculated to estimate the reliability of the scales. As a result of the analyses, PIKS (Appendix A) and PIAS (Appendix B) found to be valid and highly reliable.

#### 5. Ethics Committee Approval

The authors confirm that the ethical approval was obtained from Suleyman Demirel University Ethics Commission (Approval Number: E- 87432956-050.99-125471).

#### References

- Ay, N.A. (2018). *A look into teachers' perceptions towards intercultural competence in Turkish EFL context* (Master's thesis). Retrieved from <https://tez.yok.gov.tr/UlusalTezMerkezi/tezSorguSonucYeni.jsp>
- Barrett, M. D., Huber, J., & Reynolds, C. (2014). *Developing intercultural competence through education*. Strasbourg: Council of Europe Publishing.
- Brown, T. A. (2015). *Methodology in the social sciences. Confirmatory factor analysis for applied research (2nd ed.)*. New York, NY, US: The Guilford Press.
- Büyüköztürk, Y. (2002). Faktör Analizi: Temel Kavramlar ve Ölçek Geliştirmede Kullanımı. *Kuram ve Uygulamada Eğitim Yönetimi*, 32 (32), 470-483 . Retrieved from <https://dergipark.org.tr/tr/pub/kuey/issue/10365/126871>
- Büyüköztürk, Ş. (2007). *Veri analizi el kitabı* (7. Baskı). Ankara: Pegem A Yayıncılık.
- Büyüköztürk, Ş., Çakmak-Kılıç, E., Akgün, Ö.E., Karadeniz, Ş., & Demirel, F. (2013). *Bilimsel Araştırma Yöntemleri* Ankara: Pegem Akademi.
- Büyüköztürk, Ş., Şekercioglu, G. ve Çokluk, Ö., (2014). *Sosyal Bilimler İçin Çok Değişkenli İstatistik: SPSS ve LISREL Uygulamaları*. Ankara: Pegem Akademi Yayıncılık.
- Byram, M., Gribkova, B., & Starkey, H. (2002). *Developing the Intercultural Dimension in Language Teaching: A Practical Introduction for Teachers*. Strasbourg: Council of Europe.

- Byram M. & Wagner M. (2017). Making a difference: Language teaching for intercultural and international dialogue. *Foreign Language Annals*. 2018;1–12. <https://doi.org/10.1111/flan.12319>
- Cohen R.J. & Swerdlik M.E. (2010). *Psychological Testing and Assessment*. Boston, McGraw-Hill Companies.
- Comrey, A., ve Lee, H. (2013). *A first Course in Factor Analysis*. New York: Lawrence Erlbaum Associates.
- Coste, D., Moore, D., & Zarate, G. (2009). *Plurilingual and Pluricultural Competence: with a Foreword and Complementary Bibliography*. Strasbourg: Council of Europe.
- Council of Europe. (2003). *Relating Language Examinations to the Common European Framework of Reference for Languages: Learning, teaching, assessment*. Strasbourg: Council of Europe.
- Çandırlı, B. (2018). A study on intercultural competence of pre-service EFL teachers through short stories (Master's thesis). Retrieved from <https://tez.yok.gov.tr/UlusalTezMerkezi/tezSorguSonucYeni.jsp>
- Çokluk, Ö., Sekercioglu, G. ve Büyüköztürk, Ş. (2016). *Sosyal bilimler için çok değişkenli istatistik*. Ankara: Pegem Akademi.
- Erkuş, A. (2012). Varolan Ölçek Geliştirme Yöntemleri ve Ölçme Kuramları Psikolojik Ölçek Geliştirmede Ne Kadar İşlevsel: Yeni Bir Öneri. *Eğitimde ve Psikolojide Ölçme ve Değerlendirme Dergisi*, 3(2), 279-290.
- Harmandaoğlu, E. (2013). Promoting intercultural competence of teacher trainees in English language departments via web 2.0 tools: a case study (Master's thesis). Retrieved from <https://tez.yok.gov.tr/UlusalTezMerkezi/tezSorguSonucYeni.jsp>
- Hinkin, T. (1995). A review of scale development practices in the study of organizations. *Journal of Management*, 21(5), 967-988.
- Hinkin, T.R. (1998). A Brief Tutorial on Development of Measures for Use in Survey Questionnaires. *Organizational Research Methods*, 1(1), 104-121.
- Hooper, D, Coughlan, J and Mullen, M (2008) Structural Equation Modelling: Guidelines for Determining Model Fit. *Electronic Journal of Business Research Methods*, 6(1), 53-60.
- Karasar, N. (2011). *Bilimsel Araştırma Yöntemleri*. Ankara: Nobel Yayınları.
- Kline, P. (1994). *An Easy Guide to Factor Analysis*. New York, Routledge.
- Muijs, D. (2004). *Doing quantitative research in education with SPSS*. London, : SAGE Publications, Ltd doi: 10.4135/9781849209014
- The UN Refugee Agency, UNHCR. *Figures at a glance*. <https://www.unhcr.org/figures-at-a-glance.html> (Retrieved on July, 2020)
- Özbakır, F. (2018). English language instructors' views and practices of intercultural competence activities at university contexts (Master's thesis). Retrieved from <https://tez.yok.gov.tr/UlusalTezMerkezi/tezSorguSonucYeni.jsp>
- Özdamar, K. (2016). *Ölçek ve Test Geliştirme Yapısal Eşitlik Modellemesi*. Eskişehir: Nisan Kitabevi Yayınları.
- Pallant, J. (2013). *SPSS survival manual: A step by step guide to data analysis using SPSS for Windows (version 12)*. Crows Nest, N.S.W: Allen & Unwin.

- Süssmuth, R. (2007). On the Need for Teaching Intercultural Skills: Challenges for Education in a Globalizing World. Pp. 195-213 in M. Suárez-Orozco (Ed.) *International Perspectives On Globalization and Education*. Berkeley, CA: UCP.
- Şencan, H. (2005). Sosyal ve Davranışsal Ölçümlerde Güvenirlik ve Geçerlilik. Ankara: Seçkin Yayıncılık.
- Tabachnick, B.G. and Fidell, L.S. (2001) Using Multivariate Statistics. 4th Edition, Allyn and Bacon, Boston.
- Tavşancıl, E. (2005). *Tutumların Ölçülmesi ve SPSS ile Veri Analizi*. Nobel Yayıncılık, Ankara.
- Worthington, R. L., and Whittaker, T. A. (2006). Scale Development Research: A Content Analysis and Recommendations for Best Practices. *The Counseling Psychologist*, 34(6), 806-838.
- Yaprak, Z. (2018). Developing critical intercultural competence in second language teacher education (Doctoral dissertation). Retrieved from <https://tez.yok.gov.tr/UlusalTezMerkezi/tezSorguSonucYeni.jsp>
- Yurdagül, H. (2005). The Congeneric Test Theory and The Congeneric Item Analysis: An Application for Unidimensional Multiple Choice Tests. Ankara Üniversitesi Eğitim Bilimleri Fakültesi Dergisi, 38 (2) , 21-47 . DOI: 10.1501/Egifak\_0000000116

**Appendix A.** Your Knowledge Base in Plurilingualism and Pluriculturalism

Please read the following statements carefully, and mark (√) in the appropriate box.

**SA**= Strongly agree, **A**= Agree, **N**= Neither agree nor disagree, **D**=Disagree, **SD**= Strongly disagree

	SA	A	N	D	SD
1. There are many different kinds of sounds used in languages {phonemes, rhythmic patterns...}.					
2. There are very many languages in the world.					
3. Systems of script may function in different ways.					
4. The relationships between the elements of an utterance (groups of words/ words) may be expressed differently from one language to another {through the word order, through endings, through prepositions/ postpositions ...}.					
5. There are similarities and differences between languages/ linguistic variations.					
6. Languages may use different ways to indicate categories/ relations {agreement/ plural/ possession...}.					
7. One can build on the (structural/ discursive/ pragmatic) similarities between languages in order to learn languages.					
8. I know strategies which one can use to resolve intercultural conflicts.					
9. I know which culture(s) one participates in.					
10. I have knowledge about cultures which are the object of formal learning/ which belong to other learners in the class/ which one finds in the immediate environment.					



11. I know several phenomena relative to the diversity of cultures.					
12. I know how one acquires / learns a culture.					
13. I am aware of my reactions to linguistic/ language/ cultural difference.					
14. I know some examples of the variation of cultural practices according to social/ regional/ generational groupings.					
15. Culture and identity influence communicative interactions.					
16. Facts/ behaviours/ speech may be perceived/ understood differently by members of different cultures.					
17. I know how cultures structure roles in social interactions.					
18. The same act may have a different meaning/ value/ function according to different cultures.					
19. Some of these norms may constitute taboos.					
20. Within a same culture there exist cultural subgroups corresponding to social/ regional/ generational sub-populations.					

### Appendix B. Your Attitudes towards Plurilingualism and pluriculturalism

Please read the following statements carefully, and mark (√) in the appropriate box.

**SA**= Strongly agree, **A**= Agree, **N**= Neither agree nor disagree, **D**=Disagree, **SD**= Strongly disagree

	<b>SA</b>	<b>A</b>	<b>N</b>	<b>D</b>	<b>SD</b>
1. I am curious about (and wishing) to understand the similarities and differences between my own language/ culture and the target language/ culture					
2. I am curious about discovering how (my own / other) language(s)/ culture(s) work(s)					
3. I accept the spread and the complexity of linguistic/ cultural differences (and the fact that one cannot know everything)					
4. I positively accept linguistic/ cultural diversity/ of others/ of what is different					
5. I have a positive attitude towards the learning of languages (and the speakers who speak them)					
6. I am likely to adapt / to be flexible in my own behaviour when interacting with persons who are linguistically/ culturally different from oneself					
7. I am confident in my capacities of observation/ of analysis of little known or unknown languages					
8. I consider my own historical identity with confidence/ pride while respecting other identities					

9. I consider every language/ culture as “something” accessible (some aspects of which are already known)					
10. I accept a social identity in which the language(s) I speak / the culture(s) I affiliate to occupy an important position					
11. I am likely to dispose myself to start a process of linguistic/ cultural decentring/ relativising					
12. I can distance myself from my own language/ culture // look at one’s own language from the outside					
13. I have an attitude of critical questioning/ a critical position towards language/ culture in general					
14. I am likely to dispose myself to modify my own knowledge/ representations of the learning of languages when these appear to be unfavourable to learning (negative prejudice)					

## Dillere ve kültürlere çoğulcu yaklaşımlar: ölçek geliştirme çalışması

### Öz

Bu makale, İngilizce öğretmenlerinin çokdillilik ve kültürlerarasılık hakkındaki bilgi ve tutumlarını anlamak için geçerli ve güvenilir ölçekler geliştirmeyi amaçlayan bir ölçek geliştirme çalışmasıdır. Nicel araştırma yöntemlerinden tarama (survey) deseni kullanılmıştır. Ölçek geliştirme aşamasında, madde havuzunu geliştirmek için literatür taraması yapılmıştır. Ardından 81 madde Dillere ve Kültürlere Çoğulcu Yaklaşımlar için Referans Çerçevesi’nden (The Framework of Reference for Pluralistic Approaches to Languages and Cultures-FREPA) uyarlanmıştır. Taslak ölçek, Türkiye’deki beş devlet üniversitesinden üçüncü ve dördüncü sınıf üniversite öğrencisi olan 349 İngilizce öğretmen adayına uygulanmıştır. Analiz sonucunda üç alt başlıktan oluşan 20 maddelik bir bilgi ölçeği ve üç alt başlıktan oluşan 14 maddelik bir tutum ölçeği elde edilmiştir. Sonuç olarak 20 maddeden oluşan bir bilgi ölçeği ile 14 maddeden oluşan bir tutum ölçeği elde edilmiştir. Çokdilli ve Kültürlerarası Bilgi Ölçeğinin (PIKS) güvenilirliği 0.829 ve Çokdilli ve Kültürlerarası Tutum Ölçeğinin (PIAS) güvenilirliği 0.874’tür. Yapılan analizlere dayanarak 5’li Likert tipinde iki farklı ölçek elde edilmiştir.

*Anahtar sözcükler:* Çokdillilik; kültürlerarası yeterlilik; ölçek geliştirme

### AUTHORS BIODATA

Atilla Özdemir is an assistant professor at the University of Suleyman Demirel. His main research interests include measurement and evaluation in education. He has published several articles in his areas of interest.

Emine Pehlivan Şişman holds a BA degree in the field of English Language Teaching, and currently works as an English Teacher for the Ministry of National Education.

Kağan Büyükkarcı is working as an Assistant Professor in the Department of English Language Teaching at Suleyman Demirel University, Turkey. He holds a P.h.D. in the field of ELT.